DECODE

**Multi-standard modem IDM 50B
User Manual v1.2n**

<http://www.decode.co.yu>

1. INTRODUCTION

1.1 Modem Overview

IDM50B is a multistandard modem for asynchronous or transparent data transmission in 300-3400 Hz voice band. For lower baud rates it uses binary frequency modulation techniques (FSK), which make it highly immune to interference and noise and permit extensive voice-band communication link utilization. For higher baud rates it uses QAM modulations with 4, 8 and 16 constellation points, depending of selected rate.

The modem supports CCITT V.29, R.38A, R.38B, R.37, R.35, V.23 and Cegelec 1200/600Bd communication standards. Table of programmable channels (Figure 1.) depicts possible utilization of audio band in FSK mode. In FSK mode the modem can operate in half or full-duplex, point-to-point or point-to-multipoint mode, with receive and transmit channels independently set. For V.29 mode, four-wire full/half duplex is default.

The modem employs advanced Texas Instruments 32-bit DSP technology, thus offering high service flexibility through programmable features. Modem configuration is performed via Hayes AT commands on separate DIAG serial port, available at front panel. AT commands may be initiated from any asynchronous terminal application using RS-232 communication interface. Additionally, for easy firmware upgrade, a bootstrap loader is provided using the same DIAG serial port.

IDM50B is designed to be use in SCADA systems mainly based upon power utility communication networks. Depending on selected mode, it can communicate through specialized, private or leased lines, radio links and power lines (PLC).

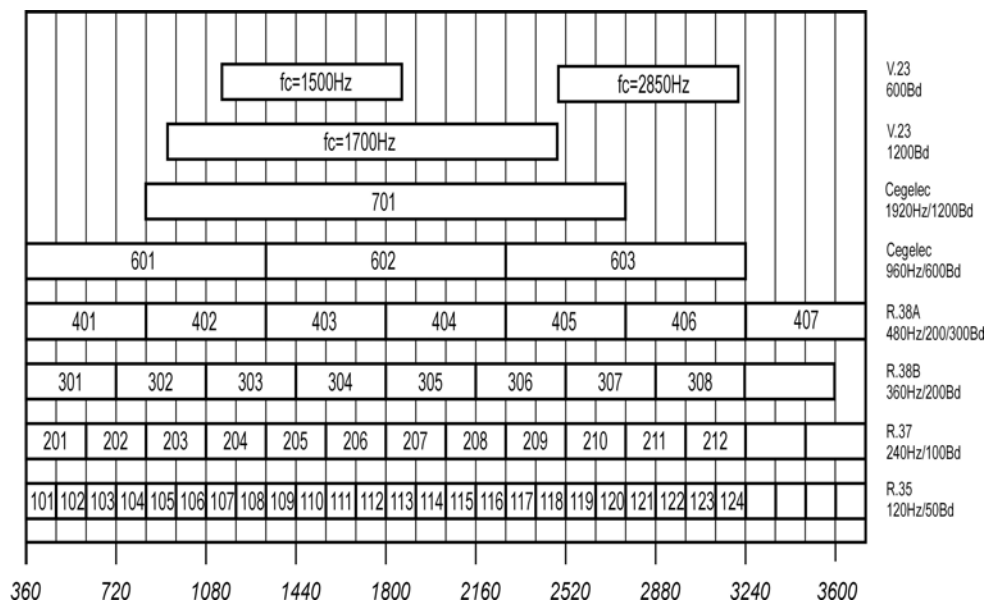

Figure 1. Table of programmable channels in FSK mode

1.2 Mounting Types

IDM50B is available as a desktop modem or in two different types of standard 19" rack:

- 1U rack with 1, 2 or 3 modems per rack;
 - 3U rack with 10,12 or 14 modems per rack,
- and additional blank front plates covering unused slots.

All connectors at the rear side are accessible at the back openings.

Please refer to Appendix A for details.

2. INTERFACES

2.1 Front Panel

- RST** Reset button is accessible on the front panel using a pin of diameter under 2 mm (pencil tip, etc.). It re-initialise all modem functions. The modem must be reset immediately on inconsistent operation appearance, before starting the maintenance diagnosis phase. This reset, like a long duration power cut-off, has no effect on the status of configurations previously loaded into the modem.
- SET** Set button is used for entering command mode (see “Entering Command Mode” section), which allows modem configuration.
- PWR** In data mode PWR LED is ON when modem is power supplied and in proper function; PWR LED is OFF in case of: power supply is not present or modem is in malfunction. PWR LED blinks slowly (100ms / 1sec cycle) as an indication of command mode. PWR LED blinks fast (100ms / 100ms cycle) when modem has locally initiated some of the test modes. PWR LED blinks slowly (1sec / 1sec cycle) when modem is remotely brought to some of the test modes.
- TXD** Transmit LED indicates data transmitted on TXD pin of RS-232 interface.
- RTS** Request to Send LED indicates state of RTS pin of RS-232 interface.
- RXD** Receive LED indicates data received on RXD pin of RS-232 interface.
- DCD** Data Carrier Detect LED indicates the presence of in-channel carrier with level higher than predefined receive level.

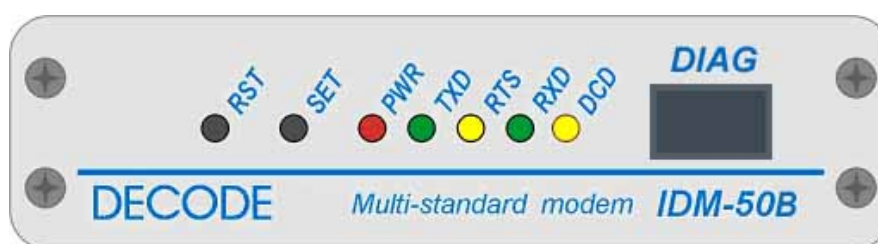

Figure 2. IDM 50B Front panel view (desktop version)

2.1.1 DIAG – Command/Bootloader serial interface

This connector is a RJ45 8 pin female type connector. It provides the interface between the modem and terminal unit in command mode and in firmware upgrade process. The following table gives the allocation and function of each pin.

PIN	ABB.	FUNCTION	DIRECTION DTE-DCE
1	SW - BSL	Switch – Bootloader selection input	x
2	GND	Signal Ground	-
3	CTS	Clear To Send	←
4	RD	Received Data	←
5	TD	Transmitted Data	→
6	RTS	Request To Send	→
7	SW - RUN	Switch – Run selection input	x
8	SW - COM	Switch – selection output	x

2.2 Rear panel connectors

Three connectors are placed at the modem's rear side (Fig. 3).

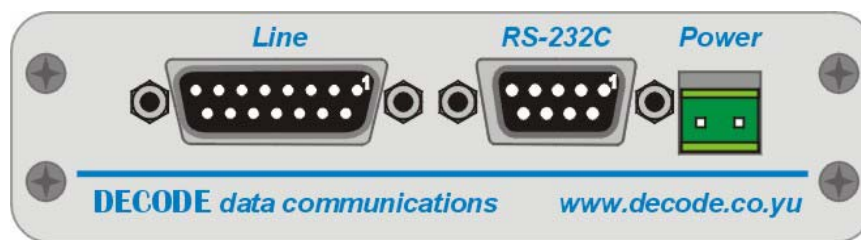

Figure 3. IDM 50B rear side (desktop version)

2.2.1 RS-232C / Data serial interface

This connector is a SUB D 9 pin female type connector with screw locking. It provides the interface between the modem and remote terminal unit or data processing equipment in data mode. The following table gives the allocation and function of each pin.

PIN	ABB.	FUNCTION	DIRECTION DTE-DCE
1	DCD	Data Carrier Detect	←
2	RD	Received Data	←
3	TD	Transmitted Data	→
4	DTR	Data Terminal Ready	→
5	SG	Signal Ground	-
6	DSR	Data Set Ready	←
7	RTS	Request To Send	→
8	CTS	Clear To Send	←
9	RI	Ring Indicator	←

2.2.2 Line / Analog interface

This connector is a SUB D 15 pin female type connector with screw locking, which provides:

- Interface between 2 or 4 wire analog line and the modem;
- The fail relay output

On the same connector modem has interface intended for communications management with a radio interface (squelch and alternate) which are not supported in current firmware version. Figure below depicts analog line interface.

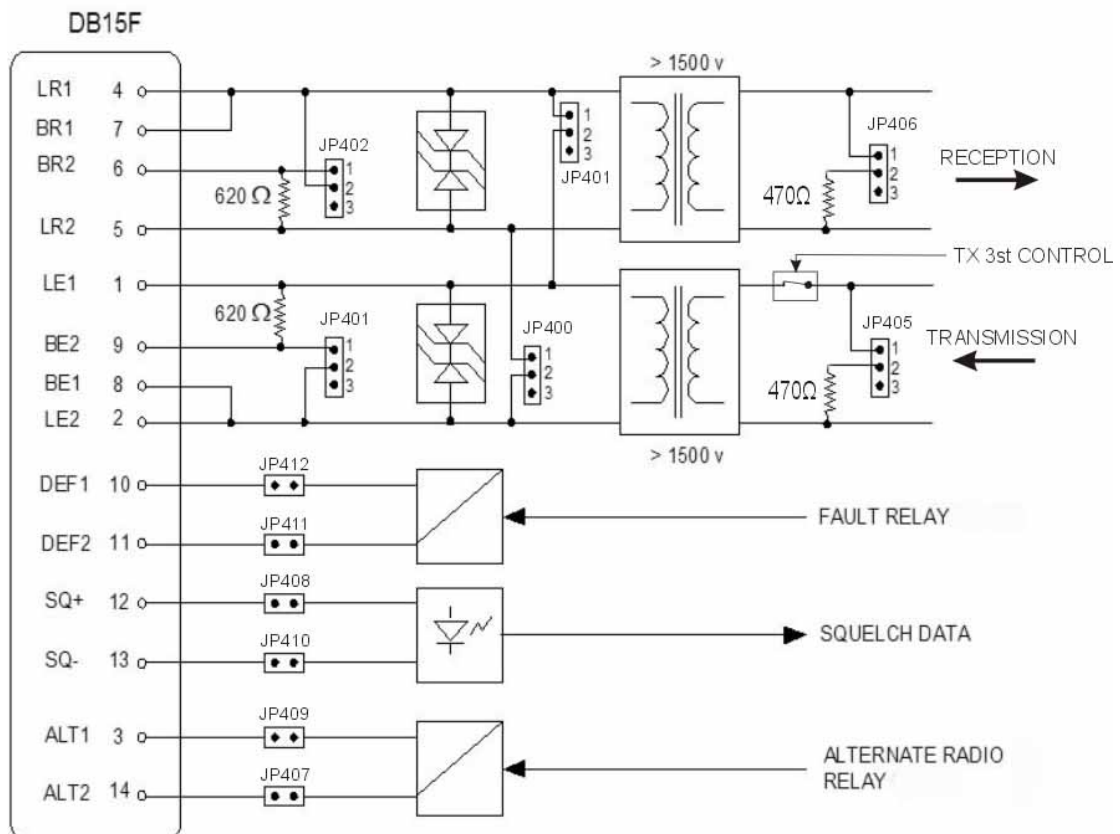

Figure 4. Analog line interface

2.2.4 Power / Power Supply

Power supply connector is a 2-position screw plug type (for 2-2.5 mm² wire) used for connecting the modem to a DC power supply. Polarity is irrelevant. Maximum consumption is 3VA. Table of possible voltage options are shown below.

Option	Nominal Voltage (V)	Voltage Range (V)	DC/DC converter on board
IDM50B - 12	12	9-18V	SCW03A-05
IDM50B - 24	24	18-36V	SCW03B-05
IDM50B - 48	48	36-72V	SCW03C-05

3. HARDWARE CONFIGURATION

Hardware configuration is performed directly on the modem board by positioning the jumpers according to the figure and the table below:

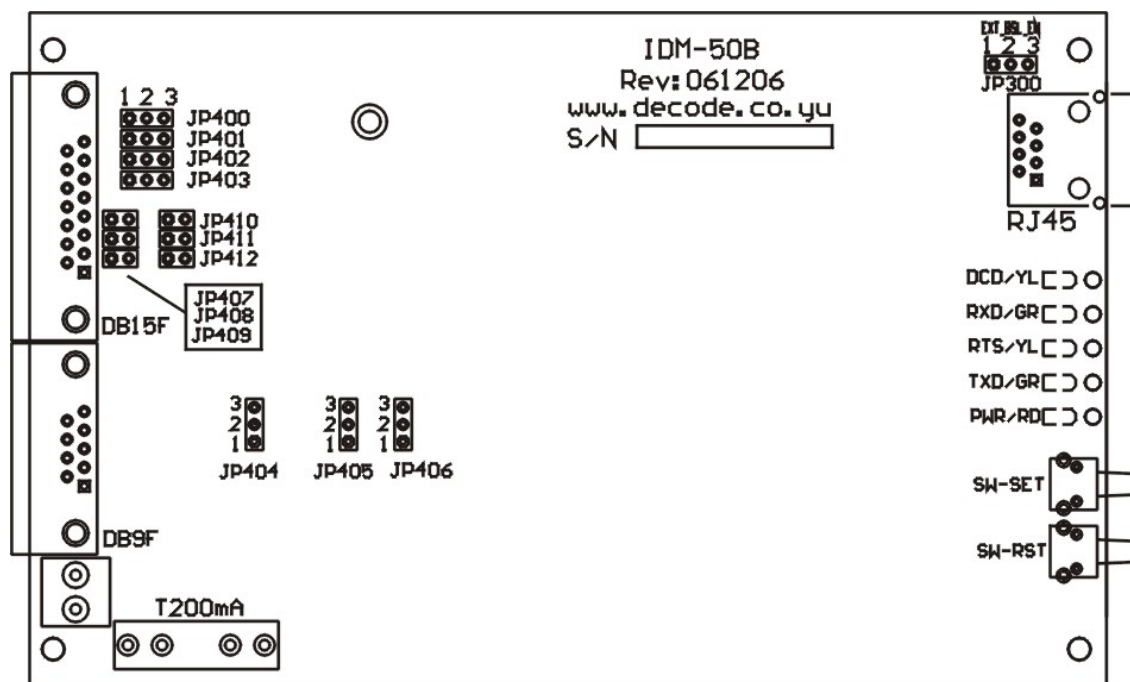

Figure 5. Jumper placement on the modem board

3.1 Jumpers placement (bold fase denotes factory default placement)

Feature	Jumpers	Option (ref. to AT&Mx command)	Jumpers Placement
2/4-wire analog line	JP400, JP403	4-wire	JP400, JP403 2-3
		2-wire (only in FSK/MUX1 or FSK/MUX2 mode)	JP400, JP403 1-2
Input & Output Impedance	JP401, JP402, JP405, JP406	4-wire (FSK and V.29 mode)	Z input 600Ω, Z output 600Ω JP405, JP406 1-2
			JP401, JP402 2-3
		4-wire (FSK/MUX1 mode)	Z input 10kΩ, Z output 600Ω JP405 1-2
			JP401, JP402, JP406 2-3
		4-wire (FSK/MUX2 mode)	Z input 600Ω, Z output 10kΩ JP402 1-2
			JP401, JP405, JP406 2-3
		2-wire (FSK/MUX1 mode)	Z = 600Ω JP405 1-2
	JP401, JP402, JP406 2-3		
Transmitter 3-state control	JP404	Transmitter 3-state control off	JP404 1-2
		Transmitter 3-state control on	JP404 2-3

Feature	Jumpers	Option	Jumpers Placement	
Alternate radio relay signal presence on connector	JP407, JP409	Proceed alternate radio relay signals ALT1 and ALT2 to connector	JP407	ON
			JP409	ON
		Do not proceed alternate radio relay signals ALT1 and ALT2 to connector	JP407	OFF
			JP409	OFF
Fail relay signal presence on connector	JP411, JP412	Proceed fail relay signals DEF1 and DEF2 to connector	JP411	ON
			JP412	ON
		Do not proceed fail relay signals DEF1 and DEF2 to connector	JP411	OFF
			JP412	OFF
Squelch data signal presence on connector	JP408, JP410	Proceed the alternate squelch data signals SQ+ and SQ- to connector	JP408	ON
			JP410	ON
		Do not proceed squelch data signals SQ+ and SQ- to connector	JP408	OFF
			JP410	OFF
Bootstrap loader operation	JP300	Enabled by switch on adapter cable	JP300	1-2
		Enabled		2-3

4. SOFTWARE CONFIGURATION

4.1 Introduction to AT Commands

A command line is a string of characters sent from a DTE to the modem (DCE) while the modem is in command mode. A command line has a prefix, a body, and a terminator. Each command line must begin with the AT character sequence and must be terminated by a carriage return. Commands entered in upper or lower case are accepted, but no combination is allowed. Characters that precede the AT prefix are ignored.

The AT command body contains printable ASCII characters (32-126). The terminator is ASCII <CR> character. The command line interpretation begins upon receipt of the carriage return character. Empty AT command containing no characters but AT and <CR> is used as an indication that modem is in command state and works correctly. Modem answers with <CR><LF>OK<CR><LF>. <CR> and <LF> are control characters that precede and follow every modem response message, so they will be omitted in following text.

The modem recognizes a backspace character (ASCII 08) after AT sequence. It clears previously typed character from modem command buffer, allowing correction of wrong entered command with no consequence.

If syntax error, invalid range or nonexistent command is detected in entered command line, modem responds with "ERROR" message. Entered command is accepted only if previous AT command is executed and acknowledged with corresponding message.

Advice: Since modem doesn't support character echoing in command mode, it is advised to activate local echo in terminal application (Telix, HyperTerminal, etc.) used for AT setting. Local echo will help to insure which characters were typed and sent to modem.

4.2 Entering Command Mode

By default, modem is in data mode. In data mode modem performs its basic function transmitting data over preset channels. While modem is in data mode it is not allowed to perform any setting procedures. To enter command mode perform following procedure:

1. Connect the communication cable to DIAG RS-232 connector at the modem front panel. Data transmission and configuration are performed over the different ports. The configuration adapter is used for firmware boot loading only.
2. a) If modem is turned off, push the SET button, turn on the modem by connecting its power supply and keep the SET button pushed approximately for 1 second.
b) If modem is already turned on, push the SET button, then push and release the RESET button while keeping the SET button pushed approximately for 1 second.
3. Modem will respond with its introductory message "IDM 50B LS vx.x" indicating command mode and firmware version.

Important: For proper modem configuration 8N1data format at 1200b/s needs to be selected in terminal application.

4.3 Commands Description

▪ Operational Mode

AT&Mx Sets FSK or CCITT V.29 operational modes. Valid values for x are:

- x = 0 FSK mode where $Z_{in/out}=600\Omega$
- x = 1 FSK/MUX1 mode where $Z_{in}=10k$ and $Z_{out}=600\Omega$
- x = 2 FSK/MUX2 mode where $Z_{in}=600\Omega/10k$ and $Z_{out}=10k$
- x = 3 V.29 mode, 4800bps
- x = 4 V.29 mode, 7200bps
- x = 5 V.29 mode, 9600bps

Example: AT&M5 command line sets 9600bps V.29 mode. Modem responds with “OK” message.

▪ Transmit Channel in FSK mode

AT&TC23/y Sets CCITT V.23/1 and V.23/2 channels for data transmission. Valid range for y is 0, 1 and 2 corresponding to V.23/0 and V.23/1 at 600Bd, and V.23/2 at 1200Bd channels, respectively.

AT&TC701 Sets Cegelec 1200Bd 701 channel for data transmission.

AT&TC60x Sets Cegelec 600Bd 60x channels for data transmission. Valid range for x is 1-3, corresponding to channels 601 to 603.

AT&TC40x/y Sets CCITT R.38A 200/300Bd channels for data transmission. Valid range for x is 1-7, corresponding to channels 401 to 407; valid range for y is 1, 2 corresponding to 200, 300Bd channels baud rate, respectively.

AT&TC30x Sets CCITT R.38B 200Bd channels for data transmission. Valid range for x is 1-8, corresponding to channels 301 to 308.

AT&TC2xx Sets CCITT R.37 100Bd channels for data transmission. Valid range for xx is 01-12, corresponding to channels 201 to 212.

AT&TC1xx Sets CCITT R.35 50Bd channels for data transmission. Valid range for xx is 01-24, corresponding to channels 101 to 124.

Example: AT&TC402/2 command line sets channel 402 at 300Bd data rate for data transmission. Modem responds with “OK” message.

▪ Receive Channel in FSK mode

AT&RC23/y Sets CCITT V.23/1 and V.23/2 channels for data reception. Valid range for y is 1, 2 corresponding to V23/0 and V.23/1 at 600Bd, and V.23/2 at 1200Bd channels, respectively.

AT&RC701 Sets Cegelec 1200Bd 701 channel for data reception.

AT&RC60x Sets Cegelec 600Bd 60x channels for data reception. Valid range for x is 1-3, corresponding to channels 601 to 603.

AT&RC40x/y Sets CCITT R.38A 200/300Bd channels for data reception. Valid range for x is 1-6, corresponding to channels 401 to 407; valid range for y is 1, 2 corresponding to 200, 300Bd channels baud rate, respectively.

AT&RC30x Sets CCITT R.38B 200Bd channels for data reception. Valid range for x is 1-8, corresponding to channels 301 to 308.

AT&RC2xx Sets CCITT R.37 100Bd channels for data transmission. Valid range for xx is 01-12, corresponding to channels 201 to 212.

AT&RC1xx Sets CCITT R.35 50Bd channels for data transmission. Valid range for xx is 01-24, corresponding to channels 101 to 124.

Example: AT&RC123 command line sets channel 123 at 50Bd data rate for data reception. Modem responds with "OK" message.

▪ Reverse FSK frequencies

AT&RFx Sets frequencies order in FSK modes. When set to "0" then normal FSK frequencies order are set and -F corresponds to data line SPACE condition and +F corresponds to data line MARK condition. When set to "1" then reverse FSK frequencies order are set and -F corresponds to data line MARK condition and +F corresponds to data line SPACE condition. If invalid range is entered, modem responds with "ERROR" message, otherwise responds with "OK" message.

Example: AT&RF0 command line sets normal FSK frequencies order. Modem responds with "OK" message.

▪ Transmit Level

AT&TLxx Sets transmission level in dBm units in 1dB steps. Valid range for FSK is 0 to 32, corresponding to 0dBm to -32dBm, except in FSK/MUX2 mode where range is 06 to 32, corresponding to -6dBm to -32dBm. If invalid range is entered, modem responds with "ERROR" message, otherwise responds with "OK" message.

Notice: Transmit level is referred to loaded output.

Example: AT&TL8 command line sets -8dBm transmit level. Modem responds with "OK" message.

▪ Receive Level

AT&RLxx Sets receive level in dBm units in FSK mode. In V.29 mode receive level is fixed to $R = -26\text{dBm}$ and this settings is ignored. For FSK mode received level R is adjustable by step of 1dB in range from 0 to -36 dBm. Signal is detected at $R - 9\text{ dB}$ or grater; signal loss is detected at $R - 12\text{ dB}$ or lower. Detection limit is at $R - 12\text{ dB}$ (loss of

carrier and DCD signal) with a hysteresis of 3 dB (detection of carrier and DCD signal at R – 9 dB). The minimum reception level is –48 dBm.

Example: AT&RL27 command line sets receive level at –27dBm. Modem responds with “OK” message.

▪ **Serial Interface Mode**

AT&S1x Sets serial interface mode. Valid values for x are 0 to 6. In transparent data mode with x=0, adjusting carrier control to DOX mode is invalid.

x = 0 Transparent data, no buffering
x = 1 Asynchronous data, with buffering
x = 2 Indactive Master, bit-synchronous data, no buffering
x = 3 Indactive Slave, bit-synchronous data, no buffering
x = 4 Indactive Master, asynchronous data, buffering
x = 5 Indactive Slave, asynchronous data, buffering
x = 6 ITU-R M.493-11 asynchronous data, buffering

Example: AT&S11 command line sets serial interface to asynchronous mode. Modem responds with “OK” message.

▪ **RTS/CTS Delay**

AT&CTSxxxx Sets delay between Request to Send (RTS) from the DTE and confirmation by the modem in the form of Clear to Send (CTS). Valid range is 40-6825ms.

Example: AT&CTS50 command line sets RTS/CTS delay at 50ms. Modem responds with “OK” message.

▪ **Fail If DCD Off**

AT&DCDx Turns on /off “Fail if DCD off” option. For x = 0 modem FAIL relay doesn’t react on DCD changes. For x = 1 FAIL relay is switched on when DCD = 0. CD led on the modem front side follows DCD changes.

▪ **PTT When TX On**

AT&PTTx Turns on /off “PTT When TX On” option. For x = 0 modem PTT relay doesn’t react on carrier On/Off changes. For x = 1 PTT relay is switched On when carrier is On, and switched Off when carrier is Off. This relay may be used to turn On external transmission equipment (for example radio transmitters).

▪ **Use SQ Input**

AT&SQx Turns on /off “Use SQ Input” option. For x = 0 modem DCD (CD on RS-232C and front panel LE diode) follows in-channel carrier presence changes. For x = 1 modem DCD (CD on RS-232C and front panel LE diode) follows SQ input state changes. SQ input may be used for indication of in-channel carrier presence signalization when external reception equipment is used (ex. radio receivers).

▪ **Use DTR**

AT&DTRx Turns on /off “Use DTR” option. For x = 0 state of DTR input is overridden and assumed that is always set to 1. For x = 1 DSR signal is copied to DTR signal. Modem works properly only when DTR = 1.

▪ Carrier control

AT&CCx Selects transmission carrier control mode. For x=0 transmission is always on and carrier is permanent. For x = 1 transmission is active only if RTS = 1 (Data Terminal Equipment requires to send). For x = 2 transmission is active only if there is data in transmission buffer. This mode is called DOX - Data Operated Xmission.

Important: If half-duplex mode is configured, it is obligatory to set “Transmission on RTS” or DOX option. Otherwise, modem would permanently transmit on a half-duplex line, disabling line access to other modems connected to it.

▪ Character Format

AT&CFdps Selects the number of data bits, parity and stop bits. Valid range for data bits is 5 to 8; for parity is N(one), E(ven), O(dd); for stop bits is 1 or 2. For FSK modulations due to restrictions associated with logic regeneration in asynchronous mode, the modem uses resynchronisation procedure at reception. In this mode the character format is between 5 and 9 useful bits, enclosed with 1 start and 1 stop bit. The parity bit, and additional stop bit is considered as a data bit and will be transmitted without processing, therefore for example, transmission and reception of 9N1 format is possible with FSK modulations with 8E1 or 8O1 settings.

Example: AT&CF8N1 command line sets format: 1 start / 8 data / 1 stop bit. Modem responds with “OK” message.

▪ Display Configuration

AT&V Displays current modem configuration in following form:

Example:

```
AT&V
OPERATING MODE:      FSK
TX CHANNEL:          V.23/1200Bd
TX LEVEL:             -9dB
RTS/CTS DELAY:       50ms
RX CHANNEL:          V.23/1200Bd
RX LEVEL:             -15dB
REVERSE FSK:         NO
FAIL IF DCD OFF:     NO
PTT WHEN TX ON:      NO
USE SQ INPUT:        NO
USE DTR:              NO
CARRIER CONTROL:    DOX
SERIAL INTERFACE:    ASYNC
DATA FORMAT:         8N1
LOCAL ADDRESS:       0
REMOTE ADDRESS:      0
```

Notice: Firmware upgrade doesn't change configuration, except if it is especially mentioned in firmware release.

▪ Store Configuration

AT&W Stores current modem configuration in non-volatile memory to be preserved after switching off the modem. After successful storage modem responds with “OK” message.

Notice: All changes introduced in command mode will be lost if “store configuration” command is not executed before switching off the modem.

- **Display Modem Info**

ATI Displays full modem info (manufacturer, model, type, firmware version and date) in following format: “DECODE IDM 50B LS vx.x dd/mm/yy”.

4.4 Test modes

IDM 50 modem provides on-line test and control functions, such as remote feedback looping and the transmission of test sequences, thus making possible to measure in-channel signal level and count bit errors. This possibilities considerably improve commissioning and maintenance of telecommunications links.

Tests may be initiated when modem is in command mode, by sending test command string from the PC or terminal. There are 3 types of test commands: INTERNAL, LOCAL and REMOTE. Generic test command format is **AT&TSTx**, where **x** represent number of test. Before entering test mode modem return "ENTERING TEST MODE x" where x represents number of test.

INTERNAL TEST – Allows validating the correct operation or not of the DSP and Codec which generates, decodes and processes signals exchanged with the analog line.

AT&TST0 Self test – internal test of DSP and Codec. No line signal is generated nor received during this test. After less than one second modem automatically return to command mode and returns "OK" message.

LOCAL TESTS – Enable validation of entire generation, transmission and reception chain of modem. In this tests modem generate and transmit specific test signal and at the same time performs receiving function with receive signal level measuring. Measurements are of narrow-band in-channel type. During tests PWR led blinks fast (100ms / 100ms cycle), DSR and CTS signals at RS-232 interface are active, DCD led and DCD RS-232 signal indicate receive signal strength but no RxD signal at RS-232 is received. External loop-back wiring may be attached at DB15 connector to route transmitted test signal back to receiver. Test 1 use 800Hz test signal while tests 2, 3, 4 and 5 are performed on pre-programmed TX and RX channels with pre-assigned TX and RX levels.

Exit from this tests, and return to command mode may be accomplished by sending any character from terminal or PC to modem. Modem returns values of received level in dB units, and duration of test in seconds.

AT&TST1 800Hz generation and detection – generation, transmission and reception chain with 800Hz test signal.

AT&TST2 Sequence F- - generation, transmission and detection of lower frequency of the channel. Valid only in FSK mode.

AT&TST3 Sequence F+ - generation, transmission and detection of upper frequency of the channel. Valid only in FSK mode.

AT&TST4 Sequence F+/F- - generation, transmission and detection of both significant frequencies of channel in alternate and symmetrical sequence. Valid only in FSK mode.

AT&TST5 Received Level - measurement of reception level in dB but without generated and transmitted signal.

Example:

```
AT&TST3
ENTER TEST MODE 3
EXIT TEST MODE
TEST STATUS: OK
RX LEVEL:    -08dBm
ELAPSED SEC: 00000007
```

REMOTE TESTS – This feature makes possible to perform testing of remote modems, in FSK mode, on point-to point and multipoint links with selective addressing of the remote modem. Every modem, when is in data mode, search received data for remote loop-back command pattern with its own (local) address. When local or own address is recognized, modem proceeds to internal loop-back mode with RS-232 signal isolated from DTE. Addressed modem remains it that state until carrier is lost. Other modems on the same network stay in stand-by mode during the tests. All remote modems, in internal loop-back or stand by mode, indicate remote test by slow PWR led blink (1sec / 1sec cycle).

Remote test command pattern on IDM50B modem is compatible with IDM50 modem and with DM50 modems from Cegelec and consists of seven characters as follows:

0AAh 0AAh 05Ah 05Ah <remote address> 0A5h 0A5h

There may be maximum 32 different addresses (0 to 31) on one and the same network.

There are two addresses in every modem, and they may be adjusted with two AT commands.

AT&L x **Local Address** – specify modem own address. Used as modem address when in data mode. Must be saved with AT&W command in non-volatile memory to be valid after power up.

AT&R x **Remote Address** – specify address of remote modem, which will be addressed with remote commands in command mode. After entering the command mode remote address is initialized from non-volatile memory.

There are 4 remote test commands. All of them first issue remote loop-back command to remote modem addressed with specified remote address. If remote loop may not be establish, error test status is returned. When remote loop are established and test is in progress, return to command mode may be accomplished by sending any character from terminal or PC to modem. Also, tests 6, 7 and 8 automatically abort and return modem in command mode in case of carrier detect failure. After returning to command mode, modem returns values of received level in dB units, and duration of test in seconds. Also, test 9 returns bit count and bit error during the test.

AT&TST6 **Remote Sequence F-** - remote test where local modem generates the F-frequency of the programmed channel, detected and returned by the remote modem. Valid only in FSK mode.

AT&TST7 **Remote Sequence F+** - remote test where local modem generates the F+ frequency of the programmed channel, detected and returned by the remote modem. Valid only in FSK mode.

AT&TST8 **Remote Sequence F+/F-** - remote test where local modem generates the F+/F-frequency sequence of the programmed channel, detected and returned by the remote modem. Valid only in FSK mode.

AT&TST9 **Remote Sequence 511 bits** - remote test where local modem generates the PN Sequence at programmed channel, detected and returned by the remote modem. This test counts number of bits sent, and error bits during the test, which indicate the bit error rate of the transmission line. Valid only in FSK mode.

Example: AT&TST9
ENTER TEST MODE 9
EXIT TEST MODE
TEST STATUS: OK
RX LEVEL: -5dBm
ELAPSED SEC: 00000175
BIT COUNT: 00033704
ERROR COUNT: 00000000

LOOPBACK MODE – This feature enable loopback at digital interface when SET switch at the front panel is pressed. This state is indicated by slow PWR led blink (1sec / 1sec cycle). Modem performs the same task as it have received remote loopback pattern. Modem turns carrier on at transmit port and expect carrier at receive port. If there is carrier signal present at receive port modem remain in loopback mode as long as carrier exists. To exit from this mode unconditionally just press RST switch at the front panel.

5. FIRMWARE UPGRADE

IDM-50B has an ability to be upgraded with new firmware in the field by performing bootloading procedure. Latest version of IDM50B firmware may be found and downloaded at no charge from Decode web site <http://www.decode.rs>.

5.1 Bootloading Procedure

Important: Before starting with bootloading procedure make sure that modem jumper JP300 is in factory settings position 1-2 (EXT_BSL). Windows operating system on your PC must have installed JAVA Runtime Environment (JRE) v1.5 or greater. It can be downloaded at no charge from:

<http://java.sun.com/j2se/corejava/>

Your PC must have at least one RS232C serial port available. Bootloader procedure may be started without modem power turn-off.

Follow steps below:

1. If you already have installed C2000Prog on your PC skip steps 2 and 3.
2. Unzip bootloader program *C2000Prog_v1.2d.zip* on your PC. It may be found on IDM50B support CD or may be downloaded at no charge from:

http://www.code-skin.com/downloads/C2000Prog_v1.2d.zip

3. Start instalation. Setup window appears on the desktop.



Figure 5. C2000Prog setup program Window

Follow the installation procedure. After installation C2000Prog.exe may be found in *Start/Programs* section under the *CodeSkin* folder. You may place program icon on computer desktop by selecting *Send_To->Desktop (create shortcut)* on right-click meny.



Figure 6. C2000Prog icon

4. Connect IDM50B bootloader adapter cable (delivered as additional accessory) at IDM50B RJ45 DIAG RS-232 port. Make sure that cable switch is at RUN position.
5. Connect available PC serial COM port and bootloader adapter cable with RS-232 communication cable (delivered as additional accessory).



6. Start C2000Prog program by clicking the icon on the Desktop.
7. Select serial COM Port you are using (COM1, 2, 3 or 4). COM1 is selected in this example.
8. Select Target: 2811_API2.10_30MHz.
9. Skip Code Security Keys. All labels must hold initial FFFF value. **Warning: Do not change these values or modem DSP may be permanently locked, after uploading of new firmware.**
10. Skip Flash Sector to be Erased.
11. Tick Smart Sector Selection.
12. Click at Program command button. File selection dialog appeared. Select and open new firmware file. File format is Intel hex, with *.hex* extension. File name must be with *idm50Bxx* format, where *xx* is firmware version.
13. When programming window appeared, change the switch position at BSL, and reset modem by short press at RST button on the front panel.

14. At this point erasing and programming of modem flash must be observed. It may last about 20 to 30 seconds.
15. When firmware upload is finished, close the programming dialog and exit C2000Prog program.
16. Return the switch in RUN position, and perform the modem reset by short press at RST button on the front panel.
17. Now modem must be in data mode with PWR led ON and with new firmware in flash.
18. You may now enter command mode (section 4.2 Entering Command Mode) and perform ATI command to check version of loaded firmware.

APPENDIX A

A1. IDM 50B Rack 1U (up to 3 modems)

Figure A1a. Rack frame 1U/84TE - Front view

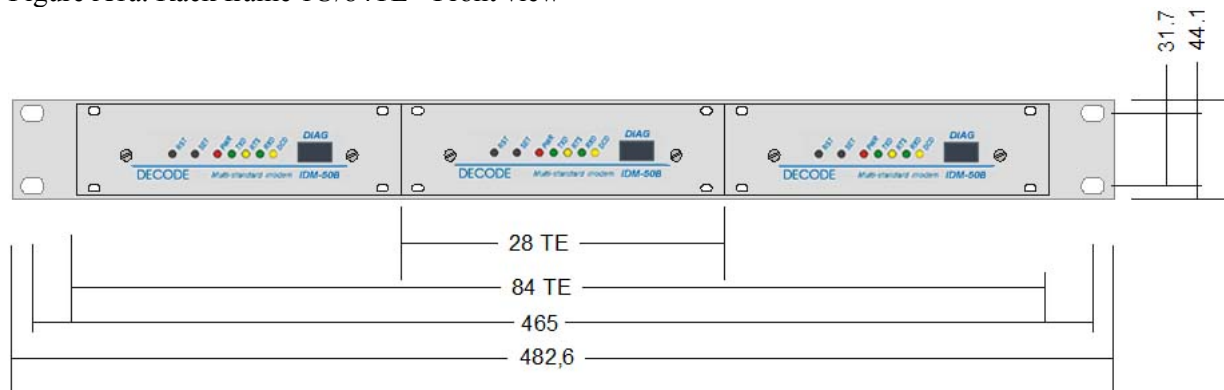

Figure A1b. Rack frame 1U/84TE - Rear view

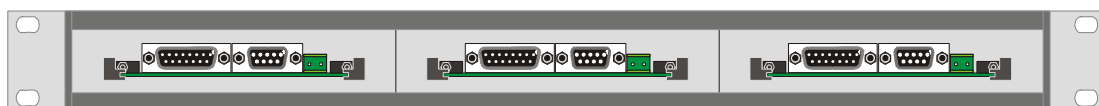

Figure A1c. Rack frame 1U/84TE - Side view

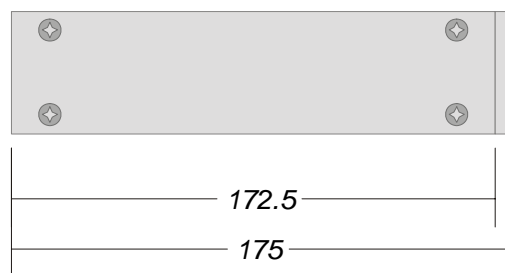
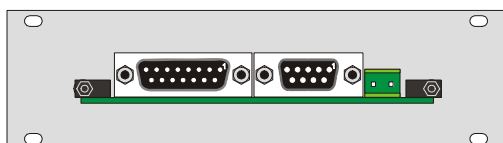

Figure A1d. Rack 1U/28TE - Front plate view



Figure A1e. Rack 1U/28TE - Rear view



A2. IDM 50B Rack 3U (up to 14 modems)

Figure A2a. Rack frame 3U/84TE - Front view

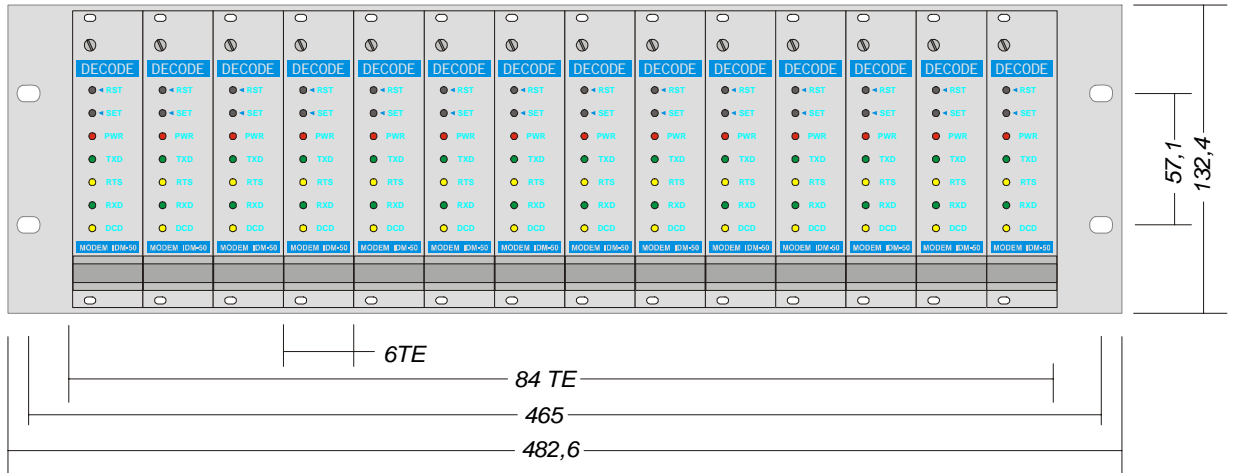
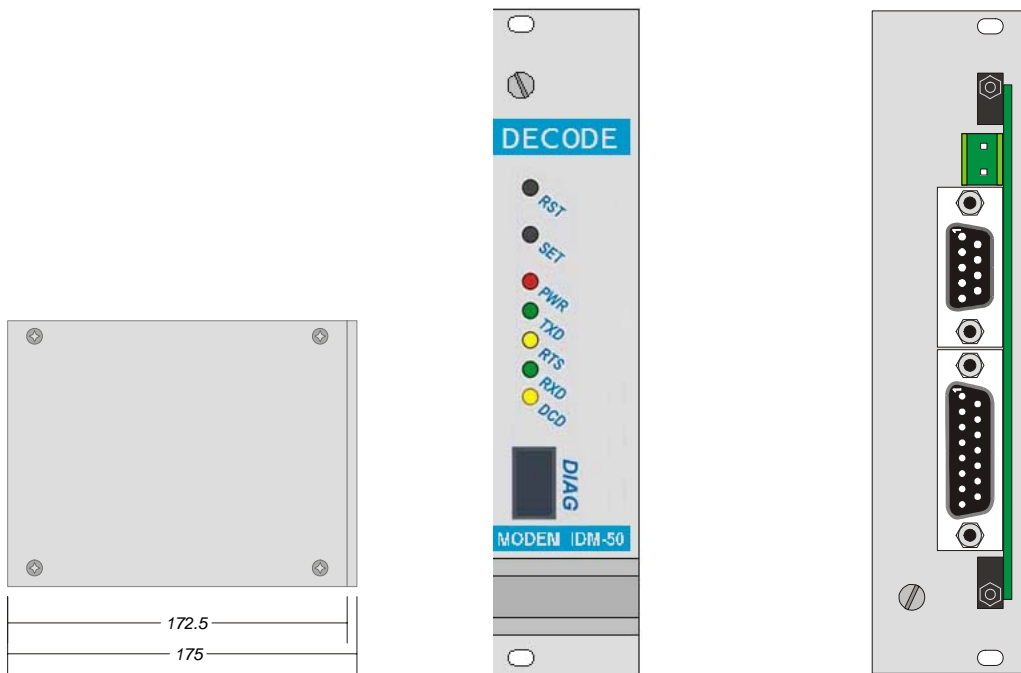
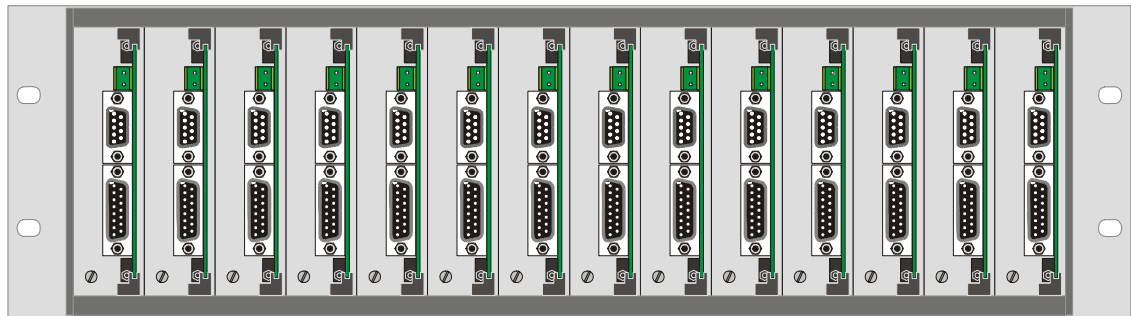

Figure A2b. Rack frame 3U/84TE - Rear view



Figures A2

c. Rack frame 3U/84TE, side view d. Rack 3U/6TE, front view e. Rack 3U/6TE, rear view

A3. IDM 50B Desktop

Figure A3a. Front view

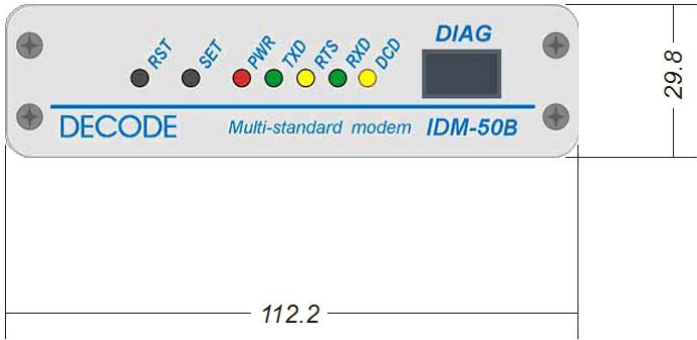

Figure A3b. Rear view

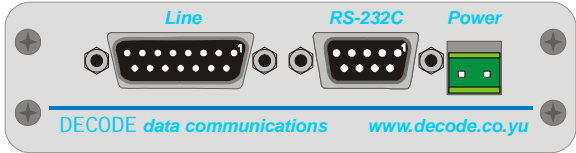
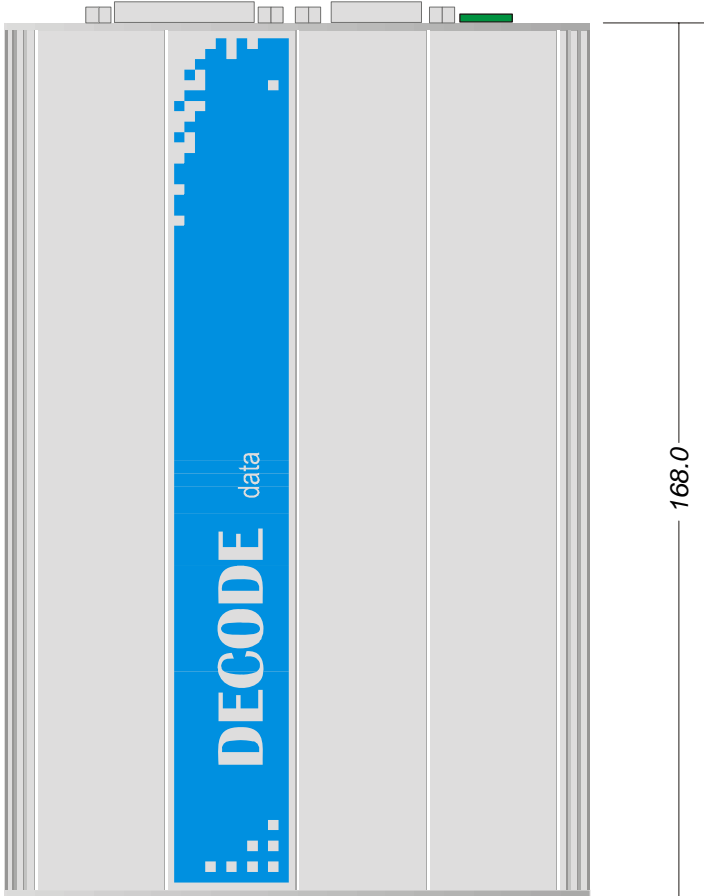

Figure A3c. Top view



APPENDIX B

DIAG serial port adapter cable

This adapter cable is designed to be plugged in RJ45 front DIAG RS232 serial port at IDM50B modem, providing standard DB9F DCE pinout on the other side of cable. DIAG port, equipped with this cable, is used for setting IDM50B modem parameters with AT commands, when switch is in RUN position, and for upgrading firmware using bootloader mode, when switch is in BSL position.

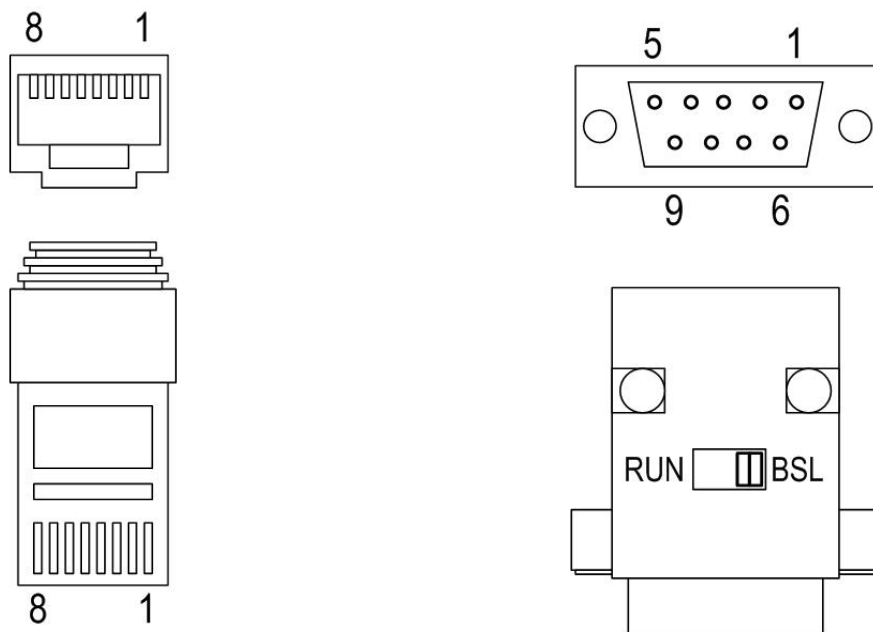

Figure B1. - RJ45 and DB9F connectors

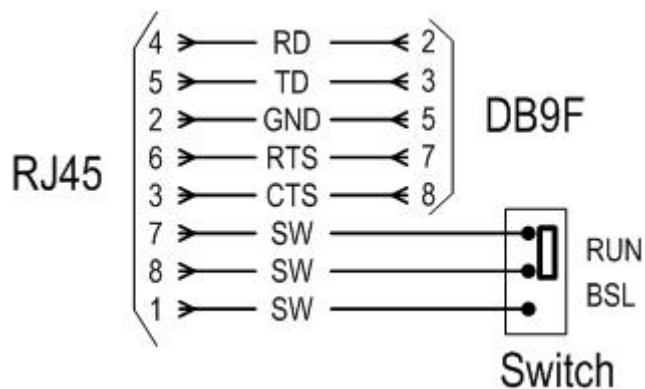

Figure B2. - Adapter cable schematics

APPENDIX C

FSK channels and frequencies table

FSK Channel	-F [Hz]	F0 [Hz]	+F [Hz]
V23/0 600bd	2650	2850	3050
V23/1 600bd	1300	1500	1700
V23/2 1200bd	1300	1700	2100
CH701	1320	1800	2280
CH601	600	840	1080
CH602	1560	1800	2040
CH603	2520	2760	3000
CH401	480	600	720
CH402	960	1080	1200
CH403	1440	1560	1680
CH404	1920	2040	2160
CH405	2400	2520	2640
CH406	2880	3000	3120
CH407	3360	3480	3600
CH301	450	540	630
CH302	810	900	990
CH303	1170	1260	1350
CH304	1530	1620	1710
CH305	1890	1980	2070
CH306	2250	2340	2430
CH307	2610	2700	2790
CH308	2970	3060	3150
CH201	420	480	540
CH202	660	720	780
CH203	900	960	1020
CH204	1140	1200	1260
CH205	1380	1440	1500
CH206	1620	1680	1740
CH207	1860	1920	1980
CH208	2100	2160	2220
CH209	2340	2400	2460
CH210	2580	2640	2700
CH211	2820	2880	2940
CH212	3060	3120	3180
CH101	390	420	450
CH102	510	540	570
CH103	630	660	690
CH104	750	780	810
CH105	870	900	930
CH106	990	1020	1050
CH107	1110	1140	1170
CH108	1230	1260	1290
CH109	1350	1380	1410
CH110	1470	1500	1530
CH111	1590	1620	1650
CH112	1710	1740	1770
CH113	1830	1860	1890
CH114	1950	1980	2010
CH115	2070	2100	2130
CH116	2190	2220	2250
CH117	2310	2340	2370
CH118	2430	2460	2490
CH119	2550	2580	2610
CH120	2670	2700	2730
CH121	2790	2820	2850
CH122	2910	2940	2970
CH123	3030	3060	3090
CH124	3150	3180	3210